

HYDRAULIC EVALUATION OF SOME IRRIGATION DRIPPERS COMMONLY USED IN EGYPT

Abdelsalam H. S.¹, El-Ansary M.Y.¹, Awad, M.A.¹,
Mostafa, H.M.¹, and Sultan, W.M.²

ABSTRACT

In Egypt, most of the newly reclaimed lands depend mainly on drip irrigation systems. The selection of good and appropriate drippers is the first step for successful drip irrigation system design. As well as, the uniformity of water application from drip irrigation system is affected by both water pressure distribution in the pipe network and hydraulic properties of drippers. Therefore, this study aimed to evaluate some irrigation drippers under different operating pressures and spacing on different lateral lengths widely used in Egyptian agriculture. The required hydraulic tests and measurements were conducted at National Irrigation Laboratory of Agricultural Engineering Research Institute (AEnRI), ARC, MOLAR, Egypt. These tests were carried out using 11 drippers of normal (non pressure compensated) and pressure compensated, on line and in line types of drippers with nominal discharges of 2, 4, and 8 L/h. All the drippers were tested and replicated thrice at operating pressure (0.5 , 0.75, 1 and 1.25 bar), while all the drip irrigation lateral lines tests were at 100bar operating pressure for treatments of 0.25, 0.50 and 1.00 m drripper spacing on PE lateral lines of 25 , 50 and 75 m lengths and 16 mm diameter.

Results indicated that, for the normal (Non-Pressure Compensated) drippers located at 1m apart on lateral lines of 25, 50 and 75m lengths the emission uniformity (EU) values were 97.45, 96.87 and 85.4%, respectively, when the drippers located on spacing of 0.5 m apart; the EU slightly reduced to 95.5, 95.3 and 81.5 %, respectively, while, for drippers spaced at 0.25m apart, EU significantly reduced to 90.4, 84.6 and 77.2 % respectively.

¹ Post graduate student, Prof. Emeritus and Associate Prof. of Ag. Eng., Fac. of Agric., Benha Univ.

²Senior Researcher of Agric. Eng. Res. Institute (AEnRI), ARC, MOLAR, Egypt.

For pressure compensated (PC) drippers located at spacing of 1 m apart on 25, 50 and 75m lateral lengths, the emission uniformity (EU) were 97.7, 94.8 and 86.4%, respectively. At drippers spacing of 0.5 m apart; the emission uniformity (EU) were 95.6, 92 and 83.8 % , while at dripper spacing 0.25m apart, the emission uniformity (EU) were 94.4 ,90.3 and 82.6%, respectively. So, emission uniformities of PC drippers were higher than that of normal NPC drippers especially at narrow dripper spacing and/ or long lateral lines.

For friction losses in the 16 mm diameter PE lateral lines of 25, 50 and 75 m lengths with 4 L/h drippers located at spacing of 1m apart, the actual measured friction losses were very close to the values created from theoretical calculation by Hazen -Williams equation using $C= 140$.

Keywords: *Drip irrigation, Emission Uniformity, Friction Losses, Laterals.*

INTRODUCTION

Drip irrigation systems are in extensive use in Egyptian new lands due to its high control of the applied water. During recent years, numerous drip irrigation drippers with varying characteristics have become available in the Egyptian market. Through a properly designed drip system, a uniformity co-efficient of at least 85% is considered appropriate for standard design requirements. Such a high uniformity coefficient is only possible through properly designed drippers that provide steady discharge to all emission points, (Al-Amond, 1995). Qualitative classification standards for the production of drippers, according to the manufacturer's coefficient of dripper variation (CVm), have been developed by ASAE. CVm values below 10% are suitable and $> 20\%$ are unacceptable (ASAE, 2005). The dripper discharge variation rate (qvar) should be evaluated as a design criterion in drip irrigation systems; $qvar < 10\%$ may be regarded as good and $qvar > 20\%$ as unacceptable (Camp et al., 1997). Barragan and Wu (2005) stated that the total friction pressure loss could be considered as the allowed friction pressure loss to meet the set design criterion. A smaller value for the design coefficient means a less allowable friction drop that requires a design with a larger sub-main size and a shorter length of

lateral line and a higher cost of the micro-irrigation system in the field. An ideal hydraulic design is to obtain the minimum pressure variation or a range of pressure variations close to the minimum for a given total friction pressure. The Objective of this work was to study the effect of some engineering factors (operating pressure, distance between dripper and lateral line length) on drip irrigation performance to assess the hydraulic performance of various kinds of drippers widely used in Egypt. Mizyed and Kruse (2008) reported that manufacturing variations, pressure differences, dripper plugging, aging, frictional head losses, irrigation water temperature changes, and dripper sensitivity result in flow rate variations even between two identical drippers. Also, the dripper operating characteristics tend to fluctuate over passing time. Thus flow might change even with a constant pressure. In fact using the manufacturer's data will lead to non-uniformity of discharge throughout the system (Singh et al., 2009). The performance of drip irrigation system is based on the proper design of drippers, spacing of drippers and proper spacing between delivery lines etc. But the design of drippers plays a prime role in uniform distribution of water on the field. To have the best emission uniformity and minimum flow rate fluctuation due to pressure distribution, some of the drippers have been designed as pressure compensating dripper. Some of them are self-cleaning or 'flushing' to reduce the clogging but others can be clogged easily and require sophisticated water filtration (Amir, 2012). The uniformity of water application from drip irrigation drippers depends on lateral lines length, drippers design, operating pressure, friction losses, the manufacturing variation of drippers and dripper's tendency to clogging. The uniformity of water is related to the pressure variation along the lateral line. The friction losses and the lateral line inclination largely affect the pressure variation (Sinobas and Rodríguez, 2012). The hydraulic analysis in order to obtain the discharge in any kind of dripper is another concern in drip irrigation design. Resolution of this problem is important to determine the efficiency of the system, which is called Emission Uniformity (EU). Different methods are discussed to calculate the dripper discharge throughout the system and each one has its own advantages and disadvantages (Rodríguez, 2012).

MATERIALS AND METHODS

This research was conducted at National Irrigation Laboratory of Agricultural Engineering Research Institute (AEnRI), Dokki, Giza. The objectives of this study were to collect discharge rates at 4 different pressure levels of 0.5, 0.75 , 1, and 1.25 bar to assess the hydraulic performances of 11 types of drippers (these drippers were available on the Egyptian market and its characteristics are presented in Table (1)). The evaluation parameters were to calculate the Coefficient of manufacturing variation, dripper discharge coefficient and discharge exponent, in order to establish the dripper's flow rate sensitivity to pressure and comparing the results to the manufactures' specifications.

The drip irrigation systems test facility (Fig. 1) was used to evaluate hydraulic characteristics of drippers.

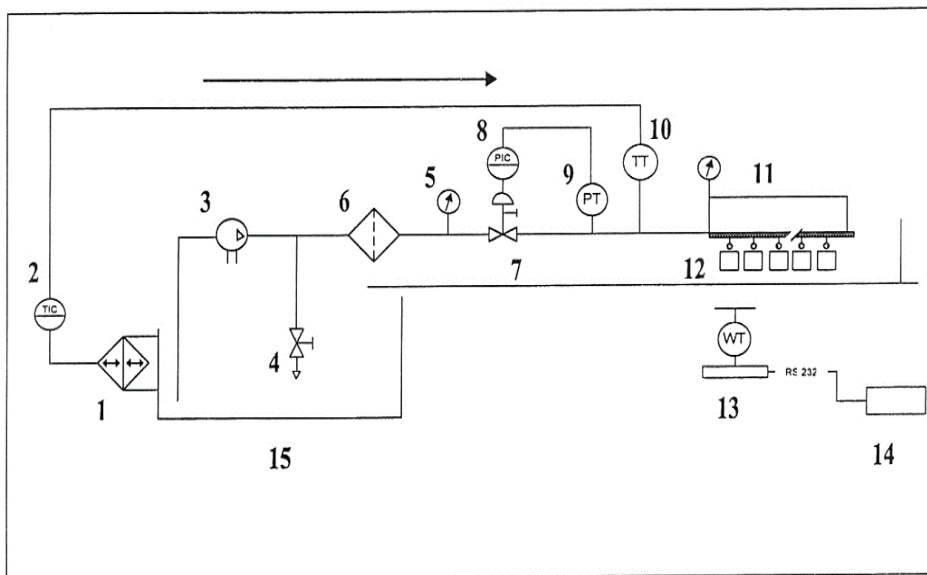

Fig. (1): Drip irrigation test facility.

- | | |
|---|--|
| 1-Temperature conditioning; | 2-Temperature regulator; |
| 3-Multi stage pumping unit; | 4-Manual discharge valve; |
| 5-Direct reading pressure gauge; | 6-Screen filter; |
| 7-Pressurized air regulating valve; | 8-Pressure regulator; |
| 9- Pressure transmitter; | 10- Temperature transmitter; |
| 11- Lines of pipes including tested drippers; | 12- Water collectors for each dripper in test; |
| 13- Weighing scale; | 14- Personal computer; and |
| 15- Water tank. | |

Poly Ethylene laterals (LDPE) of 16 mm outer diameter, 1.3 mm thickness, 3 m length, and 0.5m dripper spacing were alternatively laid on zero-slope soil surface and tested in laboratory. For lateral evaluation, (4L/h) flow rate NPC and PC drippers spaced 1, 0.5 and 0.25m apart on laterals with lengths of 75, 50 and 25m) were tested at pressure of 1 bar. The drop pressure test facility (fig.2) was used to measure friction losses.

The system was operated for a period of 15 min for each data reading, replicating thrice for each of the selected drippers. Measurements were done according to ISO 9621 and ASAE stander (1996) for evaluating drippers' performance.

Before starting the experiments, air in the lateral was flushed out by opening its downstream end. The flow rates were taken and measured by weighting the water collected in plastic cylinders in a time of 3 minutes according to ISO 9621, as indicated by stop watch, to minimize error associated with the starting and stopping of the individual runs and residual water in containers, and multiply the weighting (g/min) on 0.02 in order to turn the weight to size (L/h) to calculate and evaluate the dripper performance.

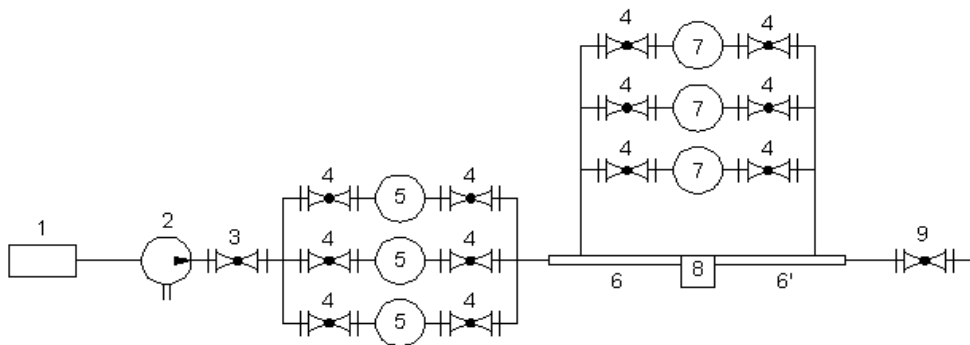

Fig (2) General sketch showing pressure drop test facility.

- | | | | |
|----|------------------------------|-----------|-------------------------|
| 1. | Water source | 2. | Pump |
| 3. | Discharge valve | 4. | Manual isolating valves |
| 5. | Electromagnetic flow meters | 6 and 6'. | Set of straight pipes |
| 7. | Differential pressure gauges | 8. | Device to be tested and |
| 9. | General ball valve. | | |

Table (1): Drippers type and its classification:

No	Dripper type	Flow rate (L/h)	Classification	Dripper's Picture
1	OT 1	2	(NPC)	
2	OT 2	4	(NPC)	
3	OT 3	8	(NPC)	
4	Button SD	4	(NPC)	
5	GR1	2	(NPC)	
6	GR 2	4	(NPC)	
7	GR 1 PC	2	(PC)	
8	RAIN BIRD	4	(PC)	
9	NEIN EPC	4	(PC)	
10	EDEN	5	(PC)	
11	Supertif	8	(PC)	
NPC: Non Pressure Compensating and PC: Pressure Compensating				

Flow rate characteristics and variations:

The dripper flow rates are usually characterized by the relationship between flow rates and pressure. The equation for dripper flow rates can be expressed as (Keller and Karmeli, 1974):

$$q = kp^x$$

Where,

q = the dripper flow rates, (L/h),

k = a dimensionless constant of proportionality that characterizes each dripper,

p = Operating pressure, (bar), and

x = a dimensionless dripper flow rate exponent that is characterizes by the flow regime.

The dripper flow variation q_{var} was expressed by Wu and Gitlin (1983) and Wu 1997 to simply compute uniformity of the drip system as followed:

$$q_{var} = \left(\frac{q_{max} - q_{min}}{q_{max}} \right) \times 100$$

Where :

q_{var} = is dripper flow variation (%)

q_{max} = is maximum dripper discharge (L/h)

q_{min} = is minimum dripper discharge (L/h)

Dripper manufacture's coefficient of variations (CV):

The manufacture's coefficient of variation "CV" was calculated by measuring the flow rates from a sample of the new drippers according to (ASAE 1996 Standard), as follows:

$$CV = \left(\frac{s}{q_a} \right) \times 100$$

Where,

CV= manufacturer's coefficient of dripper variation, (%);

q_a = Average flow rate, (L/h), and;

s = Standard deviation of dripper flow rates at a reference pressure head.

Emission uniformity (EU):

Another measure of dripper uniformity (EU) is typically used to evaluate manufacturing quality of drippers. The EU is the ratio between the average discharge in the quarter receiving less water and the average discharge at the system level. It is used to describe the predicted dripper flow variation along a lateral line and can be assumed as synonymous to that of distribution uniformity (DU).

The following formula was used to calculate Emission Uniformity (Ortiga et al., 2002).

$$EU = \left(\frac{q_n}{q_a} \right) \times 100$$

Where, EU= the emission uniformity, (%);

q_n = The average of the lowest $\frac{1}{4}$ of the dripper flow rate, (L/h),
and; q_a = The average of all dripper flow rate, (L/h).

Friction losses formula (hf):-

The Hazen –Williams's formula (Watters and Keller 1978)

$$H_f = K (Q / c)^{1.852} L f D^{-4.8655}$$

Where, H_f = head loss due to friction, m,

$$K = 1.22 \times 10^{10}$$

Q = pipe line discharge

C = friction coefficient for continuous pipe section,

D = inside diameter, mm, L = pipe line length, m, and

f = Reduction coefficient for multiple let out (Christiansen, 1942).

$$f = (1 / (m+1)) + (1/2n) + ((m+1)/6n^2)$$

Where:

m = the velocity exponent, and n = the number of outlets on the lateral

RESULTS AND DISCUSSION

Pressure –flow characteristics:

The effect of pressure on the dripper discharge varied for each dripper type. Average flow rate as a function of operating pressure was determined for all dripper types as shown in Table .2 and Fig (3). . All correlation coefficient were above (0.9), except the pressure compensating types which they have lowest correlation coefficient (0.258 and 0.016) for Supertif and EDEN respectively .Almost all on line normal (NPC) drippers were fully turbulent flow characteristics. EDEN, Supertif and GR₁PC were fully pressure compensating.

Dripper manufacture's coefficient of variation (CV):

The dripper discharge equation, and Manufacture's coefficient of variation "CV" for each dripper were determined and the results are presented in Table (2) and Fig (4). The manufacture coefficient of variation "CV" is a function of the dripper type and the quality control exercised during the manufacturing process. The manufacture's coefficient of variation "cv" of different dripper types was relatively insensitive to the operating pressure and its classification varied from poor to excellent. Values of "cv" for the 11 dripper types resulted between 0.88 to 14.9%, depending on dripper's design, the material used, and the care with which the drippers were manufactured.

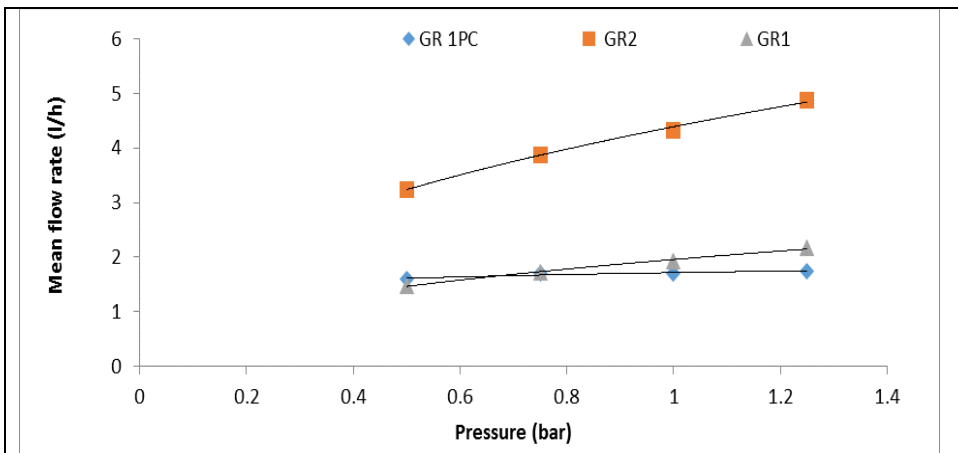
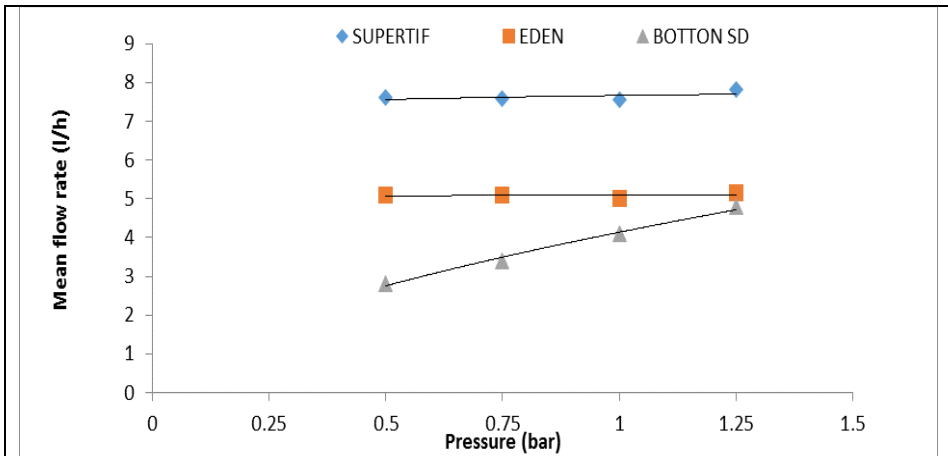
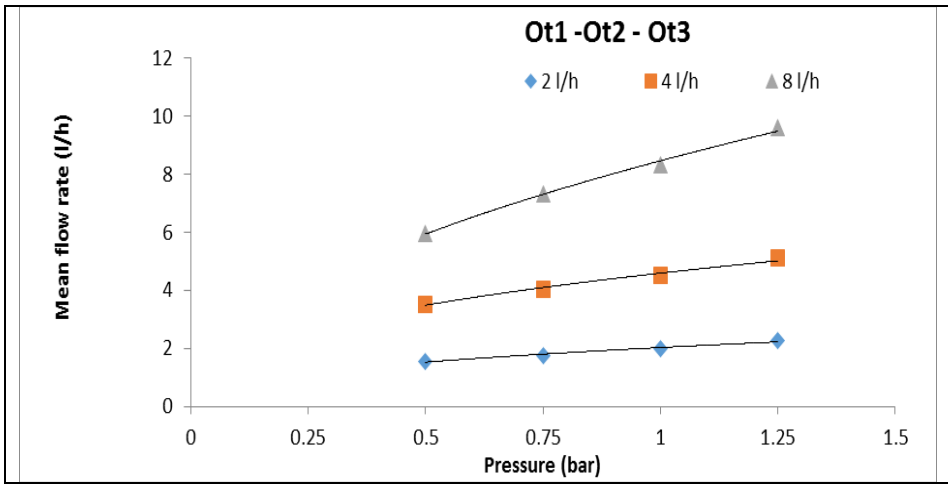

Fig 3: Performance curves of the acceptable tested dripper types.

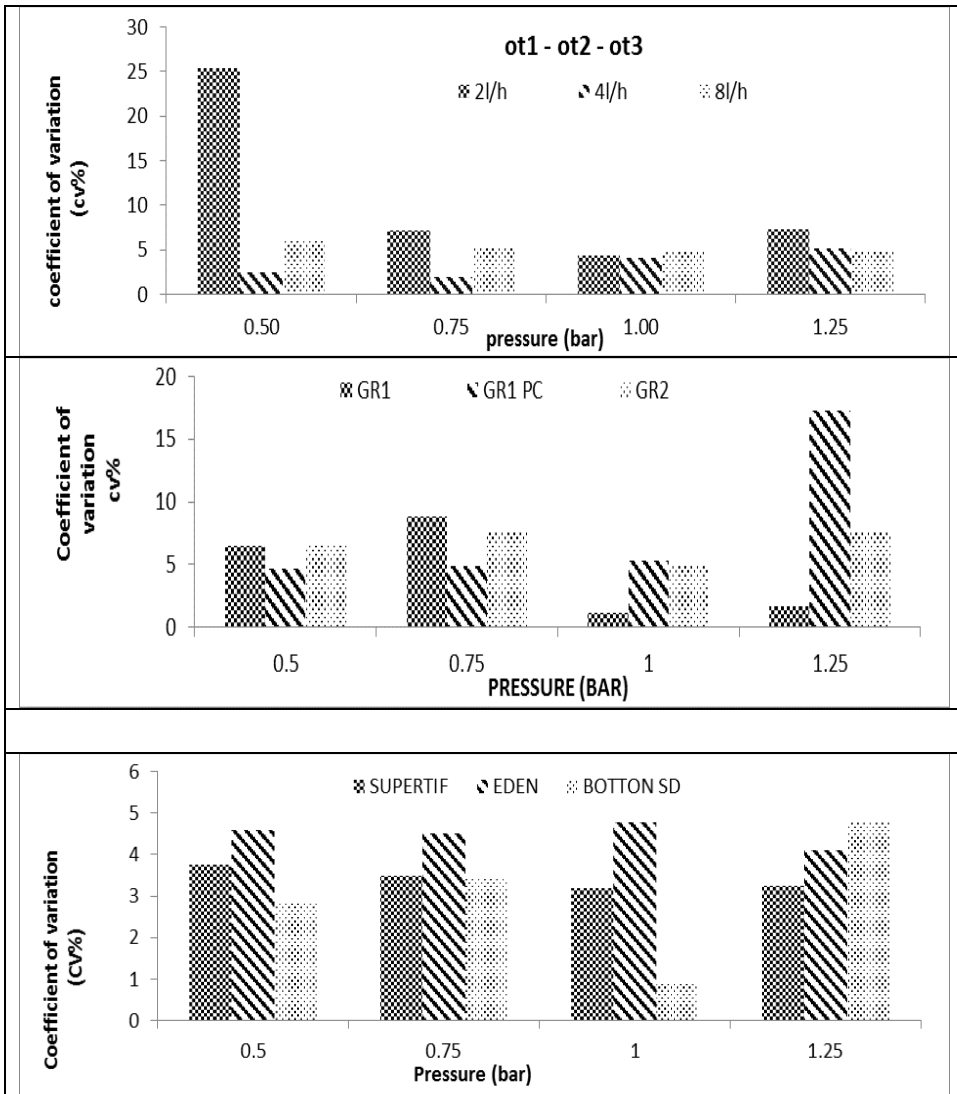

Fig 4: Manufacture coefficient of variation (CV %), for the tested drippers under different operating pressure (bar).

Emission uniformity (EU) and flow variation (q_{var}%):-

The Emission uniformity (EU) and flow variation (q_{var} %) for investigated types of drippers are presented in Table (3). EU values for the acceptable dripper types ranged from 91.8 to 98.8% which varied due to the variation of drippers manufacturing quality. Dripper flow variation (q_{var} %) was between 3.48 to 19.6 (acceptable) Fig (4).

Table (2): Manufacture's coefficient of variation (CV) % at 1 bar for the 11 dripper types:

NO	Dripper type	Flow rate,(L/h)		Manufacture's coefficient of variation (CV)% at 1bar		Parameters		Flow regime
		Nominal	Mean	CV	ASAE standard	Dripper discharge exponent (X)	Flow coefficient (K)	
1	OT 1	2	2	4.2	Excellent	0.42	2.04	Fully turbulent
2	OT 2	4	4.5	4.007	Excellent	0.4	4.6	Fully turbulent
3	OT 3	8	8.3	4.3	Excellent	0.4	8.4	Fully turbulent
4	GR 1 PC	2	1.75	4.8	Excellent	0.05	1.69	Fully pressure compensating
5	GR 2	4	4.3	4.7	Excellent	0.4	4.3	Fully turbulent
6	GR1	2	1.93	1.15	Excellent	0.4	1.9	Fully turbulent
7	RAIN BIRD	4	3.78	13.85	Poor	0.22	3.87	pressure compensating
8	NEIN EPC	4	3.8	14.9	Poor	0.274	4.17	Fully pressure compensating
9	EDEN	5	5.09	4.77	Excellent	0.006	5.08	Fully pressure compensating
10	Button SD	4	4.08	0.88	Excellent	0.49	4.08	Fully turbulent
11	Supertif	8	7.57	3.4	Excellent	0.03	7.61	Fully pressure compensating

Table (3) Emission uniformity (EU) % and dripper flow variation (q var %) for drippers at 1 bar :

Dripper type	Emission uniformity (EU)%		Dripper flow variation (qvar) %	
	Value	ASAE standard	Value	ASAE standard
OT 1	95.75	Excellent	4.25	Acceptable
OT 2	95.5	Excellent	19.2	Acceptable
OT 3	94.4	Excellent	19.3	Acceptable
GR 1 PC	92.9	Excellent	18.85	Acceptable
GR 2	92.5	Excellent	13.3	Acceptable
GR1	98.4	Excellent	7.6	Acceptable
EDEN PC NO- DRAIN	91.8	Excellent	19.6	Acceptable
Button SD	98.8	Excellent	3.48	Acceptable
supertif	94.9	Excellent	12.14	Acceptable

The effect of lateral length and spacing between drippers on emission uniformity and friction losses

Non pressure compensating

Data in Fig (5 and 6) showed that the effect of lateral length on dripper performance in using on-line drippers' lateral length 75, 50, and 25m and dripper spacing (0.25, 0.5, and 1 m) according to **ASAE, standard (1996)**. The values of that classified as fully turbulent flow. The values of emission uniformity were 85.4, 96.87, and 97.45% with 1 m space between drippers. With changing the distance between drippers to 0.5 m the values of emission uniformity were decreased to 81.5, 95.3, and 95.5%, also the EU values were decreased to 77.2, 84.6 and 90.4% with decreasing the dripper spacing to 0.25 m. The decreasing in EU values with decreasing the drippers spacing duo to the increase in drippers number at the same lateral length which affecting the dripper discharge and flow resistance due to friction.

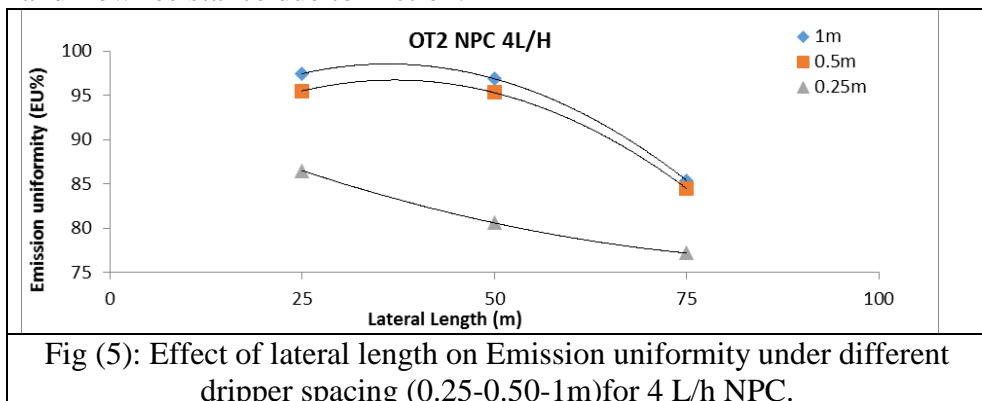
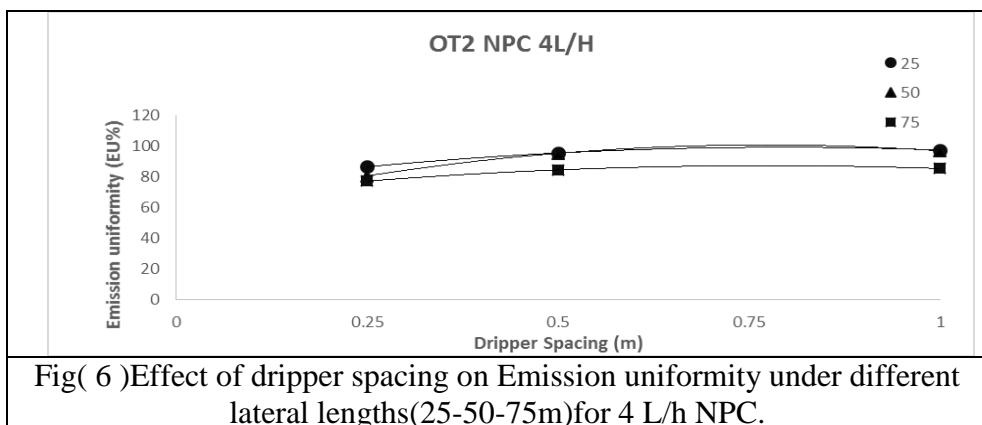

Fig (5): Effect of lateral length on Emission uniformity under different dripper spacing (0.25-0.50-1m)for 4 L/h NPC.



Fig(6)Effect of dripper spacing on Emission uniformity under different lateral lengths(25-50-75m)for 4 L/h NPC.

Pressure compensating drippers.

Data presented in fig (7 and 8) showed the effect of lateral length on emission uniformity at lengths (75, 50, and 25m) and dripper spacing (0.25, 0.5, and 1m) for pressure compensating dripper.

At 1 m dripper spacing, the values of emission uniformity were 86.4, 94.8 and 97.7% respectively, while at 0.5m the values of EU were 83.8, 92 and 95.6% respectively and at 0.25 m, they were 82.6, 90.3 and 94.4% respectively.

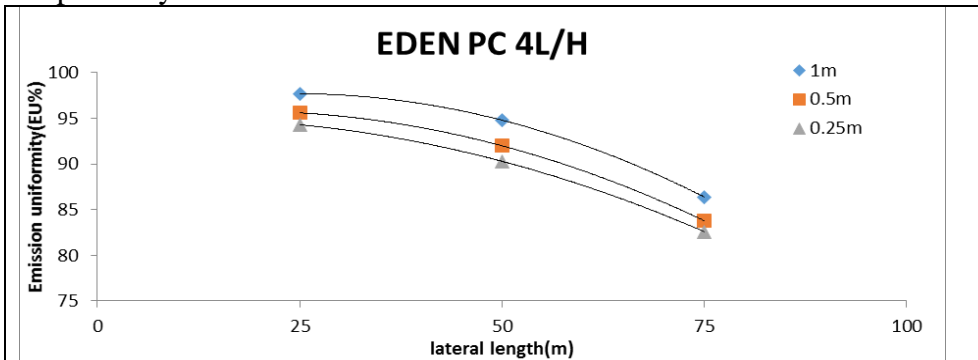

Fig (7) Effect of lateral length on Emission uniformity under different dripper spacing (0.25-0.50-1m)for 4L/h PC.

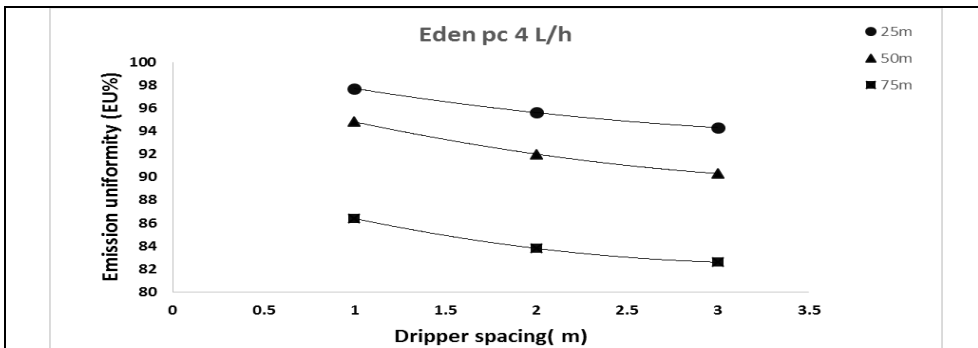

Fig (8): Effect of dripper spacing on Emission uniformity under different lateral lengths (25- 50- 75m)for 4 L/h PC.

From the previous discussion, it can be noticed that the PC (pressure compensating) drippers which have the following specification, q= 4 L/h, with spacing (1 ,0.5 ,and 0.25m) will be the acceptable one in lateral lengths(50 and 25m) compare with 75 m because it was acceptable in all

evaluating parameters. Lateral length 50 and 25 m have the highest uniformity.

Theoretical and actual friction losses:

Data in table (4) presented the theoretical and actual friction losses results for the flow rates 4 L/h drippers affected by lateral length. The data showed that for all calculations the actual measuring of the friction loss were 2, 4 and 7.2 m for the lateral length 25, 50 and 75 m respectively, when the spacing between dripper 1m. Also these data were closed to application of hazen – Williams’s equation and take the same trend which were 2.17, 4.29 and 7.43 m respectively. But with spacing 0.5m, actual measuring of the friction loss were 2.3, 5 and 6.5 m for the lateral length 25, 50 and 75 m respectively ,and the theoretical calculation were 2.19, 4.33, and 7.46m for the same lengths respectively. When spacing between dripper changed to 0.25m, the actual measuring were 2.5 ,6, and 10 m for lateral length 25,50 and 75m ,and the theoretical were 2.21, 4.39 ,and 7.26m respectively .

Table (4): Theoretical and actual Friction losses (h_f)

Lateral length (m)	Dripper spacing 1 m		Dripper spacing 0.5 m		Dripper spacing 0.25 m	
	Actual Friction losses (m)	Theoretical Friction losses (m) Hazen – Williams (C=140)	Actual Friction losses (m)	Theoretical Friction losses (m) Hazen – Williams (C=140)	Actual Friction losses (m)	Theoretical Friction losses (m) Hazen – Williams (C=140)
75	7.2	7.43	6.5	7.46	10	7.62
50	4	4.29	5	4.33	6	4.39
25	2	2.17	2.3	2.19	2.5	2.21

From the previous data it may be concluded that:-

- No significant difference between the actual and theoretical friction losses calculations according to Hazen –Williams’s equation. This may be due to the relatively short lateral lines.
- As laterals line length increased, or/and dripper spacing on the lateral line decreased, the friction losses per meters will be increased.

CONCLUSION

The manufacturing variation of emission devices has a significant effect on drip irrigation system water uniformity. The uniformity decreased by increasing the coefficient of manufacturing variation.

Uniformity coefficient is an important design and scheduling parameter.

Lateral line length was the major effective on drip irrigation line application .As lateral lines increase drip irrigation system decreasing in (EU, CV, and the type of flow).This may be due to the increasing of friction loss along the lateral line.

The lateral length of 25m and 50m were better than 75m.

Recommendation from this search:

When using on line drippers with flow rate (4L/h) at spacing 0.5m, the lateral length must be less than 75m but at spacing 0.25m lateral length must be less than 50m,that suitable for 16 mm tube .

REFERENCES

- Al-Amound, A. I. 1995. Significance of energy losses due to dripper connections in trickle irrigation lines. J. Agri. Eng. Res., 60: 1-5.
- Amir, K. (2012). Optimum Design of Drip Irrigation System using Micro-tubes as Drippers. M.Sc., School of Civil, Environmental and Chemical Engineering, College of Science, Engineering and Health, RMIT University, Australia.s

- ASAE STANDARDS,. 1996.. Field evaluation of micro-irrigation systems. St. Joseph, Mich. EP458 ASAE: 43rd ed 756-761.
- ASAE STANDARDS. 2005.. Design and Installation of micro- irrigation systems. ASAE, St. Joseph, Mich. EP405.1 FEB03
- Barragan J; Wu I P (2005). Simple pressure parameters for micro-irrigation design. Bio-systems Engineering, 90(4),4634doi:10.1016/j.biosystemseng.2004.11.009.
- Camp, C.R., E.J. Sadler and W.J. Busscher. 1997. A comparison of uniformity measure for drip irrigation systems. Transactions of the ASAE, 40: 1013-1020.
- Christiansen J.E., (1942). Irrigation by sprinkling. Ca. Agric. Exp. St. Bull No. 670. U. of Cal., Davis, Ca.
- Keller J. and D. Karmeli, (1974). Trickle irrigation design parameters. Trans. of the ASAE, 17(4): 678-684.
- Mizyed, N. and E. G. Kruse. 2008. Dripper discharge variability of subsurface drip irrigation in uniform soils: Effect on water application uniformity. Transaction of the ASAE, 26: 451-458.
- Singh, A. K., Rahman, A., Sharma, S. P., Upadhyaya, A. and Sikka, A. K. 2009. Small holders' irrigation - Problems and options. Water Resources Management, 23, 289-302.
- Sinobas L. R., and M. G. Rodríguez (2012). A Review of subsurface drip irrigation and its management, Water Quality, Soil and Managing Irrigation of Crops, Dr. TeangShui Lee (Ed.), ISBN: 978-953- 51-0426-1.
- Tagar A. A., M. S. Mirjat, A. Soomro and A. Sarki, (2010). Hydraulic performance of different drippers under varying lateral lengths. Pak. J. Agri., Agri. Eng., Vet. Sci., 26 (2): 48-59.
- Watters, G.Z., and J. Keller, (1978). Trickle irrigation tubing hydraulics. Trans. of ASAE, Pp. No. 78, 2015 ASAE, St. Joseph, Mich 49085.

Wu, I. P. and H. M. Gitlin, (1983). Drip irrigation application efficiency and schedules, Trans. ASAE,28: 92-99.

Wu I.P. (1997). An assessment of hydraulic design of micro-irrigation systems. Journal of Agricultural Water Management, 32(3): 275-284.

الملخص العربي

تقييم هيدروليكي لبعض نقاط الري شائعة الاستخدام في مصر

هبة صلاح عبدالسلام^١، محمد الانتصاري^١، منتصر عواد^١، حربي مصطفى^١، وائل سلطان^٢

من المعروف أن انتظامية اضافة المياه في النظام هي عنصر هام في تحديد طول وقطر وضغط التشغيل الأمثل لخطوط التنقيط . تعتمد انتظامية الأضافة على كل من توزيع الضغوط خلال الشبكة والخصائص الهيدروليكية للنقاط المستخدمة . لذلك تم دراسة وتقييم بعض الخصائص الهيدروليكية لأحدى عشر نوعا مختلفا من النقاط المحلية والمستوردة الشائعة الاستخدام وتقييمها لرفع كفاءة اضافة المياه لنظام الري بالتنقيط .

وقد أجريت التجارب المعملية في المعمل القومي لإختبار مكونات شبكات الري الحقلية بمعهد بحوث الهندسة الزراعية (AENRI) الدقى الجيزة، تحت ضغوط مختلفة (٠.٥ - ٠.٧٥ - ١ - ١.٢٥ بار) وتم قياس تصرف النقاط واختلاف معامل التصنيع لها وانتظامية توزيعها . أيضا تم تقييم للخطوط على أطوال (٠.٥٠-٢٥ متر) بمسافة بين النقاط (٠.٥-٠.٢٥ متر) عند ضغط ١٠٠ كيلو بسكال ، لنقاط منظمة وغير منظمة للضغط بتصرف ٤ لتر/ساعة .

أوضحت النتائج أن:

- تسعة نقاط (٣ محلية الصنع ، ٦ مستوردة) كانت ممتازة الأداء ، و٢ نقاط مستورد كانت نتائجها غير مقبولة الأداء وذلك طبقا للجمعية الأمريكية للهندسة الزراعية .
- بالنسبة للنقاط الغير منظم للضغط كانت انتظامية التوزيع لة عند طول [٠.٥٠ - ٢٥] متر ومسافة ١متر [٠.٤ - ٨٥.٨٧ - ٩٦.٧٧]، أما عند مسافة ٠.٥ متر كانت الانتظامية (٠.٣-٩٥.٥-٩٥.٥%) ، أما عند ٠.٢٥ متر كانت الانتظامية (٠.٢-٧٧.٢-٨٤.٦-٩٠.٤%) لنفس الأطوال على الترتيب.

^١ طالبة دراسات عليا- أستاذ متفرغ -أستاذ مساعد - هندسة النظم الزراعية والحيوية كلية الزراعة بمشتهر - جامعة بنها

^٢ باحث أول بمعهد بحوث الهندسة الزراعية - قسم هندسة الري الحقلية - مركز البحوث الزراعية.

- بالنسبة للنقاط المنظم للضغط كانت انتظامية التوزيع له عند طول (٢٥-٥٠-٧٥) متر ومسافة ١متر (٤.٨-٨٦.٤-٩٤.٧-٩٧.٧%) أما عند مسافة ٠.٥ متر كانت الانتظامية (٨٣.٨-٩٢-٩٥.٦%)، أما عند ٠.٢٥ متر كانت الانتظامية (٨٢.٦-٩٠.٣-٩٤.٤%) لنفس الأطوال على الترتيب.
- عند القياس الفعلي للفاقد بالاحتكاك والحساب النظري لمسافة بين النقاطات ١متر على الاطوال (٢٥-٥٠-٧٥متر)، كانت نتائج القياس الفعلية هي (٢-٢-٧.٢ متر) أما النتائج النظرية هي (١٧-٢٩-٤٣-٤٣متر) على الترتيب ، أما عند مسافة ٠.٥ متر بين النقاطات كانت القياسات الفعلية (٣-٥-٦.٥ م) اما النظرية كانت (١٩-٢-٣٣-٤٦-٧.٤ م)، أما عند مسافة بين النقاطات ٠.٢٥ متر كانت القياسات الفعلية (٥-٢-٦-١٠ م) أما الحسابات النظرية كانت (٢-٢-٣٩-٤٣-٧.٢٦ م) على الترتيب .

الخلاصة:

عند استخدام نقاطات ذات تصرف ٤ لتر/ساعة يفضل ألا يزيد طول الخط ١٦م عن ٧٥ متر وذلك لتلافي التأثير السلبي للفقد بالإحتكاك ويكون المسافة من النقاطات ٥٠ سم ويكون طول الخط ٥٠ متر للمسافة بين النقاطات ٢٥ سم.