

DESIGN AND EVALUATION OF MOBILE DRIP IRRIGATION SYSTEM

M. F. A. Khairy,⁽¹⁾ A. A. M. Elmesery⁽²⁾, F. E. Zabady⁽³⁾, and M. H. Fayed⁽⁴⁾

ABSTRACT

Mobile drip irrigation system "MDIS" consists of on/in-line drip hoses at different spaced between lines being dragged through various crops by a center pivot or lateral move irrigation system. Technology of MDIS combines the efficiency of surface drip irrigation (95%) with the flexibility and economics of center pivot and lateral move irrigation systems. While conventional center pivot and lateral move irrigation water application packages are efficient and provide many different options for distributing water. MDIS technology increased system application efficiency through precision drip irrigation with the slow methodical release of water and nutrients directly to the soil area for optimal plant growth. A mobile drip irrigation system "MDIS" was designed using the classic dripping irrigation materials and determine the best system speed which gives best wetting front advance in horizontal, vertical and diagonal directions in the loamy sand soil. The MDIS was evaluated at four system speeds of 5, 10, 15, and 20 m/h and three types of drip tubes of DT_A , DT_B , and DT_C . The results showed that the classification of all used drip tubes were fully pressure compensating and the application efficiency of MDIS was higher than 82%. Also, results obtained the mathematical relationships which describe wetting front advance in horizontal "H", vertical "V", and diagonal "D" directions in loamy sand soil.

⁽¹⁾ Prof., of Ag. power & machinery, Fac. of Ag. Eng., Al-Azhar Univ., Cairo.

⁽²⁾ Prof., of Water & Farm Irrigation Systems, Fac. of Ag. Eng., Al-Azhar Univ., Cairo.

⁽³⁾ Assoc. Prof., of Water & Farm Irrigation Systems, Fac. of Ag. Eng., Al-Azhar Univ., Cairo.

⁽⁴⁾ Assis. Lect., Water & Farm Irrigation Systems Eng., Dept., Fac. of Ag. Eng., Al-Azhar Univ., Cairo.

(This study is a part of outcomes from Fayed, M. H. "PhD thesis")

INTRODUCTION

Trickle irrigation is gaining in importance in the world, especially in areas with limited and expensive water supplies, since it allows limited resources to be more fully utilized. Replacing the sprinklers on a center pivot "CP" or linear move machine by using polyethylene "P" tubes with emitters to convey irrigation water directly to the soil surface converts a traditional CP or linear move to a mobile drip irrigation system "MDIS". In stationary drip irrigation, closed plastic tubes with emitters are used to deliver irrigation water to the plants using low pressure. No water losses due to wind drift and spray evaporation occur in sprinkler systems and especially in CP system. The idea of mobile drip irrigation system "MDIS" is a combination of the advantages of stationary drip irrigation with CP or linear move or boom trailer irrigation systems. The advantages of the stationary drip irrigation are: low operating pressure, low water losses and high irrigation efficiency. The advantages of the CP system are: low capital requirements, flexibility and low labour requirements. In addition, soil cultivation under CP is easy. The operating pressure of the drip tubes can be much lower than that of sprinkler systems. The operating pressure at the inlet of a traditional CP with sprinklers ranges from 400 to 500 *kPa* as compared with 175 to 225 *kPa* at the inlet of the MDIS (**Hezarjaribi, 2008**).

Precision mobile drip irrigation "PMDI" is an irrigation system where drip hoses are attached to a center pivot sprinkler and drag on top of the ground. The placement of water by the hoses on the ground could potentially increase irrigation efficiency over a standard drop nozzle system. In addition, problems associated with wet wheel tracks should be reduced. However, drag hoses lying on the ground could cause more management concerns for farmers. One example would be animal damage to the drip hoses which disrupts uniform water distribution (**Olson and Rogers, 2008**).

Precision mobile drip irrigation "PMDI" combines the efficiency of surface drip irrigation with the flexibility of center pivot and linear move irrigation systems. While conventional center pivot and linear move irrigation water application packages are efficient and provide many

different options for distributing water, PMDI technology provides increased system application efficiency through precision drip irrigation with the slow methodical release of water and nutrients directly to the soil area for optimal plant growth.

The PMDI system is an ideal solution for growers to maintain yields even with lower water availability. Crops can be effectively irrigated even with very low m^3/h wells. This technology provides accuracy of water management and greater efficiency than standard pivot nozzling. But best of all, it delivers the most even water pattern/application available. Growers will get all the efficiency of a subsurface drip system at a lower cost per acre versus a conventional center pivot system. Drip has proven, time and again, that it helps growers improve crop quality and yields. Water and nutrients are used more efficiently so input costs are reduced. This results in higher yields up to 20% yield increases have been recorded over a conventional center pivot system and a uniform, quality crop throughout the entire field (Netafim, 2016).

MDIS technology may develop further and be adopted as an additional irrigation system option in the Great Plains region. However, when combining moving lateral irrigation systems with micro-irrigation technologies, the constraints of both systems must be recognized and addressed (Lamm, 2003).

T-L Irrigation (2016) mentioned that the two main advantages of mobile drip irrigation system "MDIS" are:

- 1) **Overall water efficiency:** With the drip line design, eliminate evaporation and wind drift associated with traditional sprinklers because wind will not affect it as it applies the water at a super-efficient 95%. MDIS get all the efficiency of surface drip at the much-reduced cost per acre price of center pivots.
- 2) **Dry wheel tracks:** In many soils and cropping practices, deep wheel tracks on pivots and laterals are a problem. With MDIS the drip lines water behind the wheels so the tires run on dry ground.

Netafim (2016) said that the advantages of MDIS as bellow:

- 1) Potential for 20-30% water savings.
- 2) Can be used on either tall or short crops.
- 3) Significantly reduces evaporation and eliminates wind drift.
- 4) Reduces and/or eliminates wheel track issues.
- 5) Soil stays moist without crusting while soil compaction is reduced or eliminated.
- 6) Increases soil moisture resulting in more water banked into the soil profile.
- 7) Reduces plugged and frozen nozzles during winter watering.

The main objective of this study was to design of mobile drip irrigation system "MDIS" by using classic dripping irrigation materials and evaluate its performance to manage and control the options for efficient irrigation and various cultivation practices.

MATERIALS AND METHODS

Experiments were carried out in the experimental field at water and farm irrigation systems engineering department, Faculty of Agricultural Engineering, Al-Azhar University, Nasr City, Cairo, Egypt.

1. Mobile Drip Irrigation System "MDIS" Components

The present mobile drip irrigation system "MDIS" designed generally and assembled as shown in **Fig. (1)**. It includes two towers **(1)** with four driven wheels (175/70R13 82H) **(2)** for moving the system in linear desired direction. The towers carrying a water supply pipe **(3)** closed from one end, the other end was connected to water source by two Polyethylene "PE" tubes with diameter of 18 mm **(4)** by thread adapter (18 mm × 19 mm male "V") **(5)**. The water source is generally a water pump **(6)**, fertilizer apparatus **(7)** and hydraulic equipments as pressure gauge **(8)**, flow meter **(9)** and pressure regulator **(10)**. The supply pipe includes eight saddles (63mm × 12.7 mm female) **(11)** at spacing of 50 cm, each saddle connected to one end of a vertically oriented drop line assemblies **(12)** by tavit push fit elbow male thread (16 mm × 12.7 mm) **(13)**. The other end of drop line connected to manual flush valve (16 mm) **(14)**. Each valve connected to the upper end of drip tube (16 mm) **(15)** and the lower end was closed by line end (16 mm) **(16)**. PCJ on-line drippers **(17)** installed on the lower end of the drip tube which spaced above the ground.

MDIS was connected to movement unit at the end of the field by a wire of 6 mm diameter. This unit includes SEW gearmotor 1 hp, 60 Hz, 3 phase, and 48 rpm. Made in Germany. System speed was varied from 5 to 20 m/h by LS inverter, made in Korea, model name is SV008IC5-1F, single phase, and motor rating is 1 hp.

The drip tube was a blind low density polyethylene "LDPE" pipe (outer diameter of 16 mm, internal diameter of 14 mm, and maximum operating pressure of 400 kPa). A plurality of PCJ, on-line compact pressure compensated drippers was installed on PE pipe. The nominal discharge rate of single dripper was 8, 25, and 40 L/h for DT_A , DT_B , and DT_C respectively. The number of emitters installed on the drip tubes was calculating based on emitter discharge.

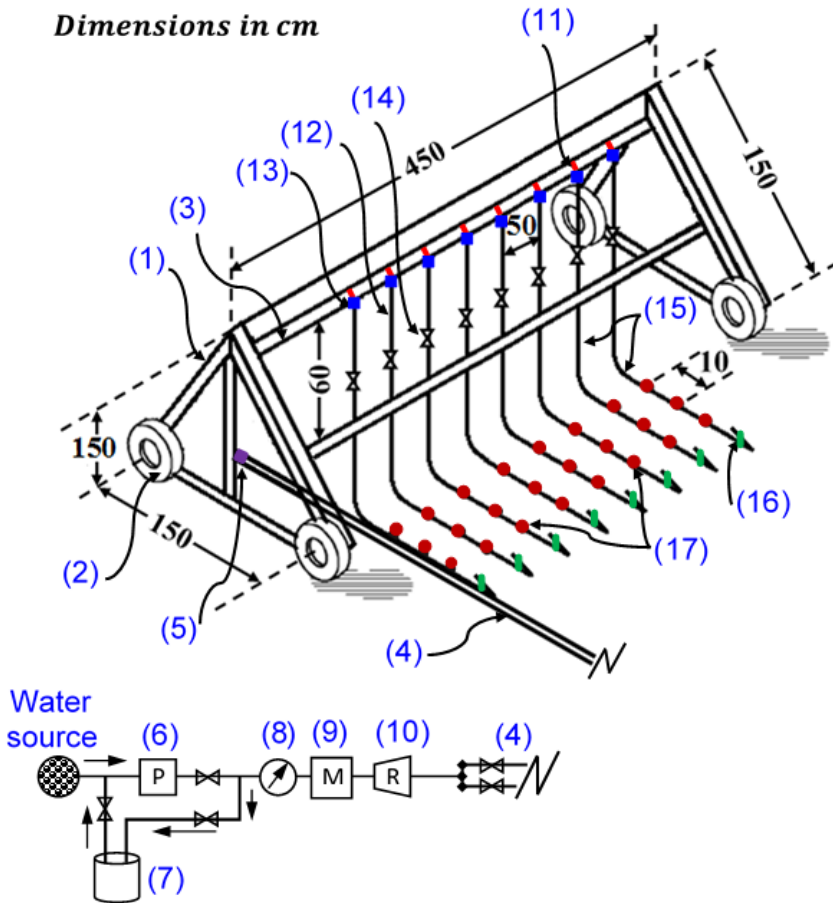

Fig. (1): Mobile drip irrigation system "MDIS".

2. Determination Number of Emitters on Drip Tube

Number of emitter drip tube were calculated as follow:

$$N_e = \frac{q_{dt}}{q_e} \dots \dots \dots (1)$$

$$q_{dt} = ET_o \times S \times F \times w \dots \dots \dots (2)$$

$$ET_o = E_{pan} \times K_{pan} \dots \dots \dots (3)$$

where N_e : Number of emitters on drip tube, q_{dt} : Discharge rate of drip tube, (L/h), q_e : Emitter discharge rate, (L/h), ET_o : Reference evapotranspiration, (mm/day), S : MDIS speed, (m/h), F : Irrigation frequency, (day), w : Distance between drip tube, (m), K_{pan} : Pan coefficient "0.55" and E_{pan} : Pan evaporation (mm/day).

3. Drip tube calibration

Three types of drip tubes (DT_A , DT_B and DT_C) were used at four operating pressures (150, 200, 250, and 300 kPa). The discharge rate (L/h) of drip tubes were measured by collecting the water dropped from each drip tube in 20 liters container and the time was recorded. Each experiment was repeated three time and the average was calculated.

3.1. Pressure-Discharge Relationship

In the design of drip irrigation systems, the relationship between emitter discharge and operating pressure is calculated based on the emitter flow function given by **Keller and Karmeli (1974)** and **Howell et al. (1980)** as follows:

$$q_e = K_d \cdot H^x \dots \dots \dots (4)$$

where q_e : Emitter discharge rate, (L/h), K_d : Constant of proportionality that characterizes each emitter, H : The working pressure head at the emitter, (m), and x : Emitter discharge exponent that is characterizes by the flow regime.

3.2. Manufacturer's Coefficient of Variation " C_v "

Coefficient of variation of the discharge C_v is one of the significant parameters related to the uniformity and efficiency of the system. It could be obtained by taking a random sample of drip tubes and measuring the discharge rates at the same temperature and pressure. It was calculated by using the following equation (**Lamm et al. 2007**):

$$C_v = Sd/q_{avg} \dots \dots \dots (5)$$

Where C_v : Manufacturer's coefficient of variation, Sd : Estimated standard deviation of the discharge rates of sampled set of emitters (L/h), and q_{avg} : The average discharge rates of sampled set of emitters (L/h)

The standard deviation values were calculated in the same manner using the following equation (FAO 2002):

$$Sd = \left(\frac{(q_1^2 + q_2^2 + \dots + q_n^2) - n(q_{avg})^2}{n - 1} \right)^{0.5} \dots \dots \dots (6)$$

where q_1, q_2, \dots, q_n : Discharge rate of emission devices tested (L/h), and n : Number of emission devices tested.

Classifications of the coefficient of discharge variation values according to ASABE standards (1994).

3.3. Emission Uniformity "EU"

In order to determine whether the system is operating at acceptable efficiency, evaluate the uniformity of emission by calculating emission uniformity by the following equation which suggested by ASAE (1994):

$$EU = 100 \times \left(1.0 - \left[\frac{1.27}{\sqrt{n}} C_v \right] \right) \times \left(\frac{q_{min}}{q_{avg}} \right) \dots \dots \dots (7)$$

where EU : The design emission uniformity (%) and q_{min} : The minimum emitter discharge for minimum pressure in the sub-unit, (L/h).

The evaluated system is classified according to the emission uniformity values obtained, following Merriam and Keller, (1978) and ASABE standards (1999) criterion which is more demanding.

3.4. Variation from Hydraulic Design "q_{var}"

Flow variation within laterals occur due to pressure head variations and manufacturing variations of the individual emitters. Both of these processes will be discussed and related as to how they can be used in the design process. Lateral emitters flow variation "q_{var}" was determined as the following equation given by Wu and Gitlin (1974):

$$q_{var} = \frac{q_{max} - q_{min}}{q_{max}} \times 100 \dots \dots \dots (8)$$

where q_{var} : Lateral emitters flow variation, (L/h), q_{max} : The maximum emitter flow rate along the lateral, (L/h), and q_{min} : The minimum emitter flow rate along the lateral, (L/h).

Wu and Gitlin (1974) recommended the general criteria for emitter flow variation " q_{var} " values which are 10% or less is generally desirable, acceptable when between 10% and 20%, and unacceptable when greater than 20%.

4. Application Efficiency

Efficiency of applying water by trickle irrigation depends on the ratio of transpiration to application " TR " and the uniformity of application " EU " (%). Application efficiency " E_a " (%) was calculated by using **Keller and Karmeli (1975)** equation:

$$E_a = TR \times EU \dots \dots \dots (9)$$

where value of $TR = 0.90$ is a reasonable management expectation.

In this study, three types of drip tubes ($DT_A, DT_B, and DT_C$) were evaluated at four speeds (5, 10, 15, and 20 m/h) of linear mobile drip irrigation system (MDIS). Application efficiency of drip tubes ($DT_A, DT_B, and DT_C$) was calculated at four operating pressures (150, 200, 250, and 300 kPa). Also, wetting front advance in three directions (Horizontal " H ", Vertical " V ", and diagonal " D ") was determined in loamy sand soil under three drip tubes ($DT_A, DT_B, and DT_C$) which used at working pressure of 200 kPa and distances between drip tubes of 100 and 50 cm. PCJ (Pressure compensating junior) on-line compact pressure compensated drippers, were used. Those nominal discharge rates are 0.5, 1.2, 2, 4, 8, 25, and 40 L/h.

RESULTS AND DISCUSSION

1. Calibration Performance of Drip Tubes

1.1. Pressure-Discharge Relationships of Drip Tubes

Fig. (2) illustrate the mean drip tubes discharge rates at different operating pressures for three types of drip tubes which namely $DT_A, DT_B, and DT_C$. The pressure-discharge relationships of drip tubes are expressed by equation (4). The values of equation constant " k_d " and exponent " x " are listed in **Table (1)**.

The results showed that all used drip tubes discharge rates were very uniformly distributed at all operating pressures. At the same time, the discharge was relatively the same at all operating pressures because the type of emitters used on drip tubes was a pressure compensating "PC".

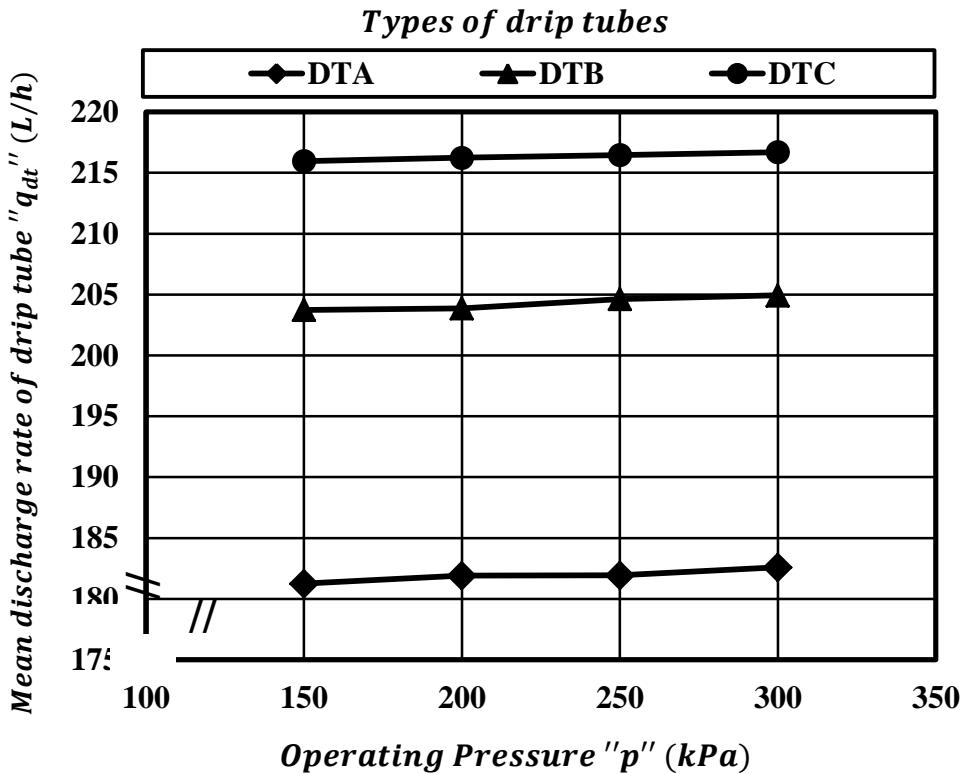

Fig. (2): Relation between mean discharge rate of drip tubes " q''_{dt} " (L/h) under study and operating pressures " p'' " (kPa).

Table (1): Values of drip tube discharge coefficient " k_d'' ", exponent " x'' ", and " R^2 " (%) of tested drip tubes and its classification according to the drip tube discharge exponent values.

Drip tube type	Drip tube discharge coefficient (k_d)	Drip tube discharge exponent (x)	R^2 (%)	Classification
DT_A	172.71	0.010	91	Fully pressure compensating
DT_B	194.60	0.009	90	
DT_C	210.84	0.005	99	

1.2. Manufacturer's Coefficient of Variation " C_v " (%) of Drip Tubes

Fig. (3) shows the relation between the manufacturer's coefficient of variation " C_v " (%) and operating pressure " p " (kPa) for drip tubes. The results indicated that the coefficient of discharge variation values for all used drip tubes were below 5%. So, the drip tubes performance was classified on the basis of the coefficient of variation as good according to recommended classification of **ASAE Standards (1994)**.

1.3. Emission Uniformity " EU " (%) For Drip Tubes

Emission uniformity was calculated using equation (7) for drip tubes (DT_A , DT_B , and DT_C) at different operating pressures (150, 200, 250 and 300 kPa). The relationship between emission uniformity and operating pressure as shown in **Fig. (4)**. The emission uniformity values for drip tubes (DT_A , DT_B , and DT_C) were ranging from 91.46 to 96.28% at all operating pressures. So, the performance of drip tubes (DT_A , DT_B , and DT_C) was classified on the basis of the emission uniformity as good according to recommended classification of **ASABE Standards (1999)**.

In general, the fluctuation of the coefficient of variation with pressure may be used to define emitter discharge sensitivity to pressure. The manufacturers coefficient of variation should be 15% or less to achieve reasonable uniformity of water application (**Solomon, 1977**).

1.4. Drip Tube Flow Variation " q_{var} " (%)

Flow variation was calculated using equation (8) for drip tubes (DT_A , DT_B , and DT_C) at different operating pressures (150, 200, 250 and 300 kPa). The relationship between flow variation and operating pressure as shown in **Fig. (5)**. The mean values of flow variation for all types of drip tube are less than 10%. So, all drip tubes were classified on basis of flow variation of drip tube as a desired according to recommended classification of **Wu and Gitlin (1974)**.

2. Application Efficiency

Application efficiency was calculated using equation (9) for drip tubes DT_A , DT_B , and DT_C at different operating pressures of 150, 200, 250 and 300 kPa . The relationship between application efficiency and operating pressure is shown in **Fig. (6)**. Application efficiency values for drip tubes

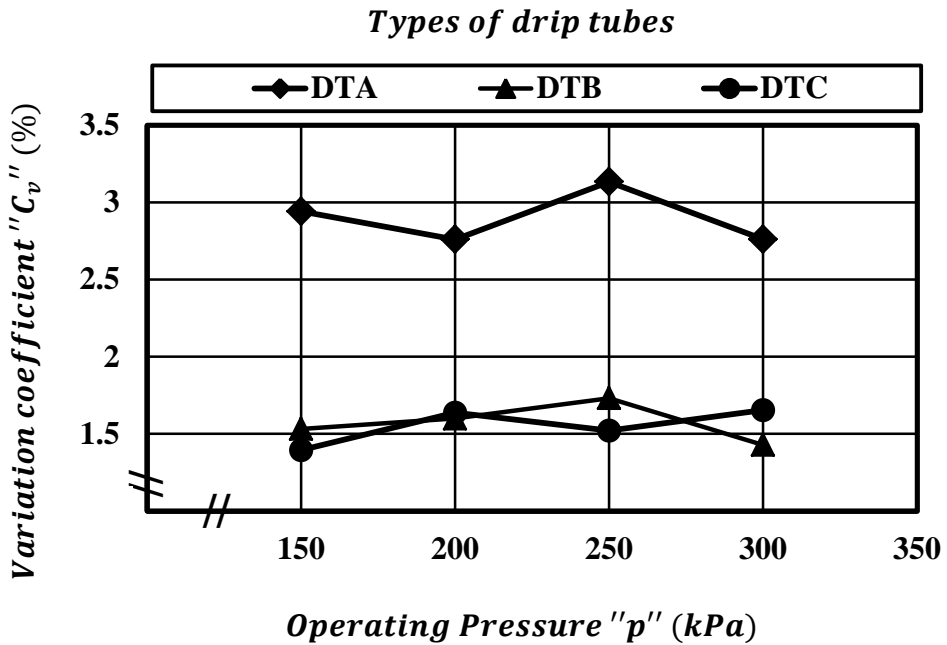

Fig. (3): Relation between the manufacturer's coefficient of variation " C_v " (%) and operating pressure " p " (kPa) for drip tubes under study.

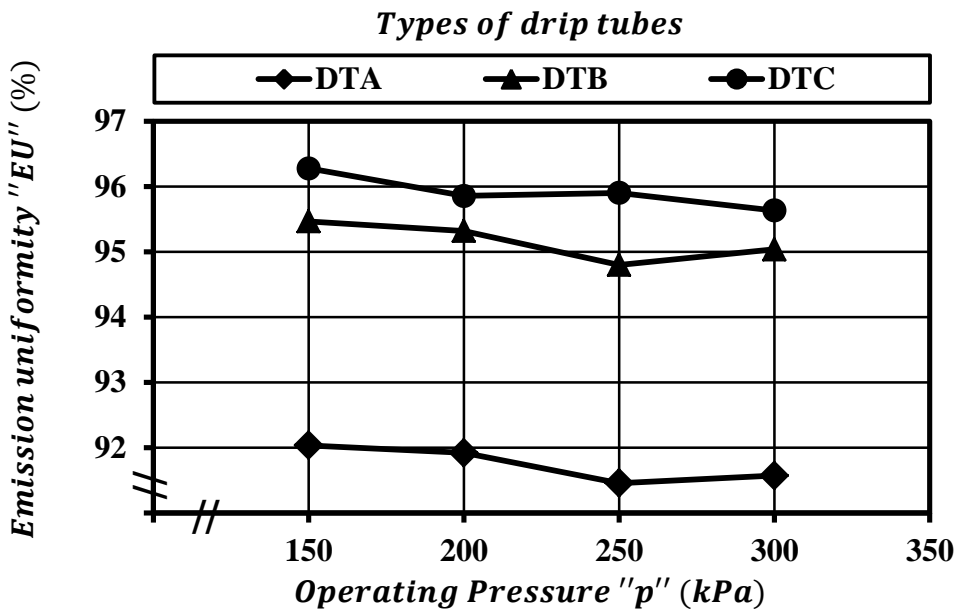

Fig. (4): Relation between emission uniformity " EU " (%) and operating pressure " p " (kPa) for drip tubes under study.

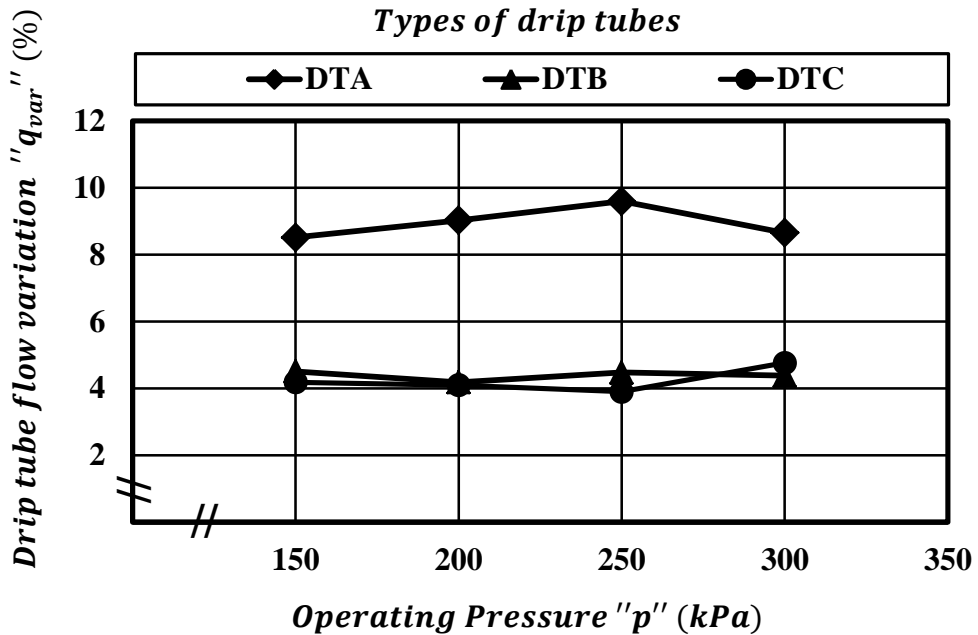

Fig. (5): Relation between drip tube flow variation " q_{var} " (%) at different operating pressures " p " (kPa).

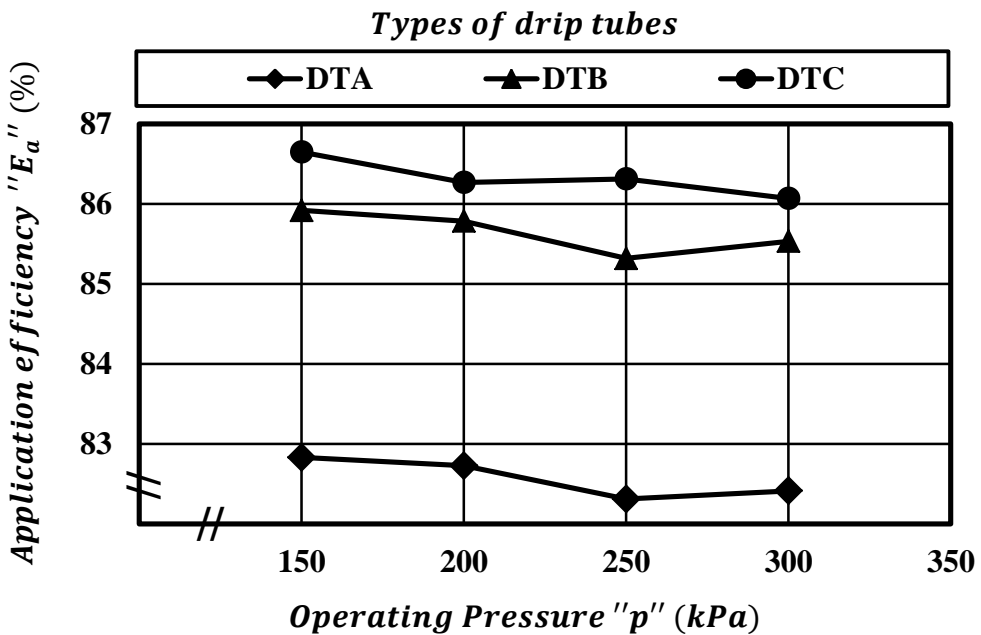

Fig. (6): Relation between drip tube application efficiency " E_a " (%) at different operating pressures " p " (kPa).

(DT_A , DT_B , and DT_C) were ranging from 82.31 to 82.83%, 85.32 to 85.92% and 86.07 to 86.65% respectively at different operating pressures. Generally, application efficiency of drip tubes increases by decrease number of emitter installation on drip tube, therefore number of emitters on drip tube increase by decrease discharge rate of single emitter installation on drip tube.

3. Wetting Front Advance in Three Directions " α "

3.1. Wetting Front Advance at 100 cm Distance Between Drip Tube

Fig (7), show the relation between horizontal wetting front advance " H ", vertical wetting front advance " V " and diagonal wetting front advance " D " and speed of mobile drip irrigation system "MDIS" " S " at different discharge rates of drip tubes " q_{dt} ", different drip tubes (DT_A , DT_B and DT_C) and 100 cm distance between drip tubes in loamy sand soil.

From **Fig (7)**, the values of horizontal wetting front advances " H " (cm) were increased by increase both discharge rate of drip tube and system speed. Wherever, the values increased from 54.7, 58.1, and 63.7 cm to 69.5, 70.7, and 70.6 cm, at using DT_A , DT_B and DT_C respectively. Discharge rate of drip tube was ranging from 0.051 to 0.206 m^3/h when using DT_A and DT_B types and from 0.045 to 0.218 m^3/h when using DT_C . Whereas, system speed was ranging from 5 to 20 m/h respectively. The values of vertical wetting front advances " V " (cm) were increased by increase both discharge rate of drip tube and system speed. Wherever, the values increased from 52.7, 48.3, and 51.3 cm to 63.5, 58.6, and 58.8 cm, at using DT_A , DT_B and DT_C respectively. Discharge rate of drip tube was ranging from 0.051 to 0.206 m^3/h when using DT_A and DT_B types and from 0.045 to 0.218 m^3/h when using DT_C . Whereas, system speed was ranging from 5 to 20 m/h respectively.

The values of diagonal wetting front advances " D " (cm) were increased by increase both discharge rate of drip tube and system speed. Wherever, the values increased from 49.8, 46.2, and 49.7 cm to 61.0, 56.9, and 57.0 cm respectively. Discharge rate of drip tube was ranging from 0.051 to 0.206 m^3/h when using DT_A and DT_B types and from 0.045 to 0.218 m^3/h when using DT_C . Whereas, system speed was ranging from 5 to 20 m/h respectively.

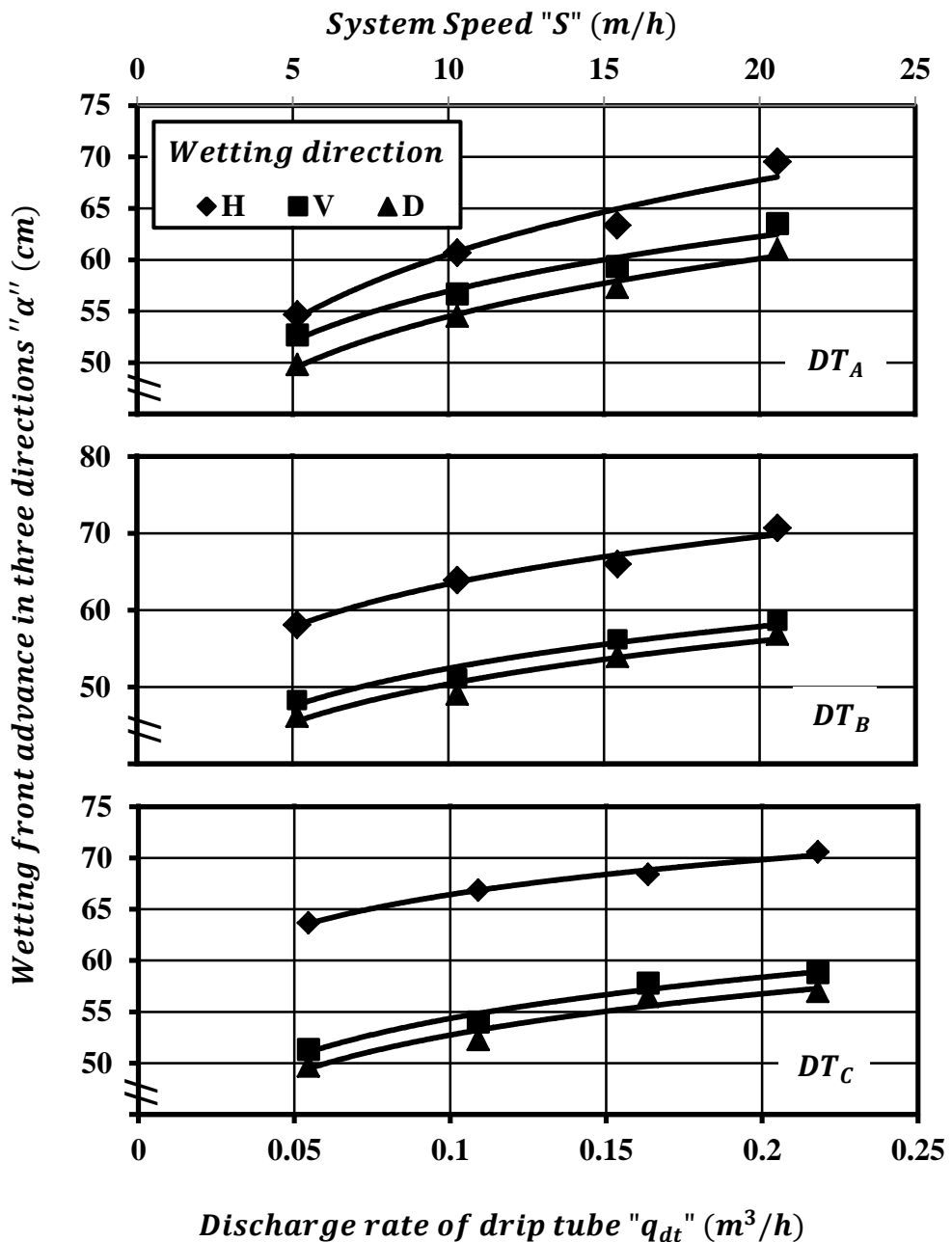

Fig. (7): Relation between discharge rate of drip tube " q_{dt} " (m^3/h) and wetting front advance " $H, V, and D$ " (cm) at different drip tubes ($DT_A, DT_B, and DT_C$) and 100 cm distance between drip tubes.

Data showed that, in case of using DT_A the wetting front advance in horizontal, vertical, and diagonal directions was relatively equal. Whereas, in case of using DT_B and DT_C the wetting front advance in horizontal direction was higher than the wetting front advance in vertical and diagonal directions. This results agreement with **Goldberg et al., (1971)**.

Generally, the mean wetting patterns as influenced by the different water application rates and MDIS speed. The horizontal width of wetting was higher than the vertical wetting depth in the highest application rate and MDIS speed treatments. Increasing the application rate and MDIS speed increased the rate of horizontal water advance, while the vertical water advance was markedly reduced as the application rate and MDIS speed increases. This could be attributed to:

- (1) The presence of soil surfaces crust, which reduced water infiltration and enhanced the horizontal water movement.
- (2) The increased saturated zone at the soil surface due to an increased application rate.

A regression analysis showed that experimental data of the $H, V, \text{ and } D$ (cm) exposed power functions in relation to discharge rate of drip tube " q_{dt} " (m^3/h) or mobile drip irrigation system speed " S " (m/h) as follows,

$$H, V, D = a \cdot q_{dt}^b \quad \dots \dots \dots (10)$$

or
$$H, V, D = a \cdot S^b \quad \dots \dots \dots (11)$$

where H : Width (horizontal) wetting front advance, (cm), V : Depth (vertical) wetting front advance, (cm), Z : Diagonal wetting front advance, (cm), q_{dt} : Discharge rate of drip tube, (m^3/h), S : Mobile drip irrigation system speed "MDIS" (m/h), and a and b : Parameters depend on direction of wetting front advance ($H, V, \text{ and } D$). soil type, and application rate.

The value of (C_v) between values of parameters " a " and " b " was very low ($C_v \leq 0.02$). Therefore, the mean values of parameters " a " and " b " were listed in **Table (2)**.

Generally,
$$\alpha = 76.146 q_{dt}^{0.127} \quad \dots \dots \dots (12)$$

or
$$\alpha = 42.859 S^{0.127} \quad \dots \dots \dots (13)$$

where α : is the wetting front advance in horizontal, vertical or diagonal directions. This results (equation (17)) agreement with **Al-Qinna and Abu-Awwad (2001)**.

Table (4.2): Values of parameters a and b at the directions of wetting front advance at using different types of drip tubes (DT_A , DT_B and DT_C) as a function at discharge rate " q_{dt} " of drip tube or a function at system speed " S ".

Factor	Wetted direction	Type of Drip tube					
		DT_A		DT_B		DT_C	
		a	b	a	b	a	b
q_{dt}	H	88.005	0.163	86.322	0.134	78.409	0.072
	V	76.592	0.129	72.812	0.143	68.899	0.103
	D	75.501	0.142	71.456	0.152	67.314	0.106
	C_v	0.09	0.12	0.11	0.06	0.08	0.20
	Mean	80.033	0.144	76.863	0.143	71.541	0.094
S	H	41.816	0.163	46.784	0.134	56.641	0.072
	V	42.499	0.129	37.887	0.143	43.259	0.103
	D	39.482	0.142	35.675	0.152	41.689	0.106
	C_v	0.04	0.12	0.15	0.06	0.17	0.20
	Mean	41.266	0.144	40.115	0.143	47.196	0.094

3.2. Wetting Front Advance at 50 cm Distance Between Drip Tube

Fig (8) shows the relation between vertical wetting front advance (V) and speed of mobile drip irrigation system (S) in loamy sand soil at different discharge rates of drip tubes (q_{dt}), different drip tubes (DT_A , DT_B , and DT_C) and 50 cm distance between drip tubes in loamy sand soil.

The values of vertical wetting front advances " V " (cm) were increased by increase both discharge rate of drip tube and system speed. Wherever, the values increased from 55.5, 50.2, and 48.2 cm to 63.0, 58.7, and 55.0 cm, at using DT_A , DT_B , and DT_C respectively. Discharge rate of drip tube was ranging from 0.027 to 0.109 m^3/h when using DT_A and DT_C types and from 0.026 to 0.103 m^3/h when using DT_B . Whereas, system speed was ranging from 5 to 20 m/h respectively. The deeper wetting front advance was at using DT_A at all system speed. The wetting front advance in horizontal (H) and diagonal directions (D) do not measured because of an overlapping in the wet.

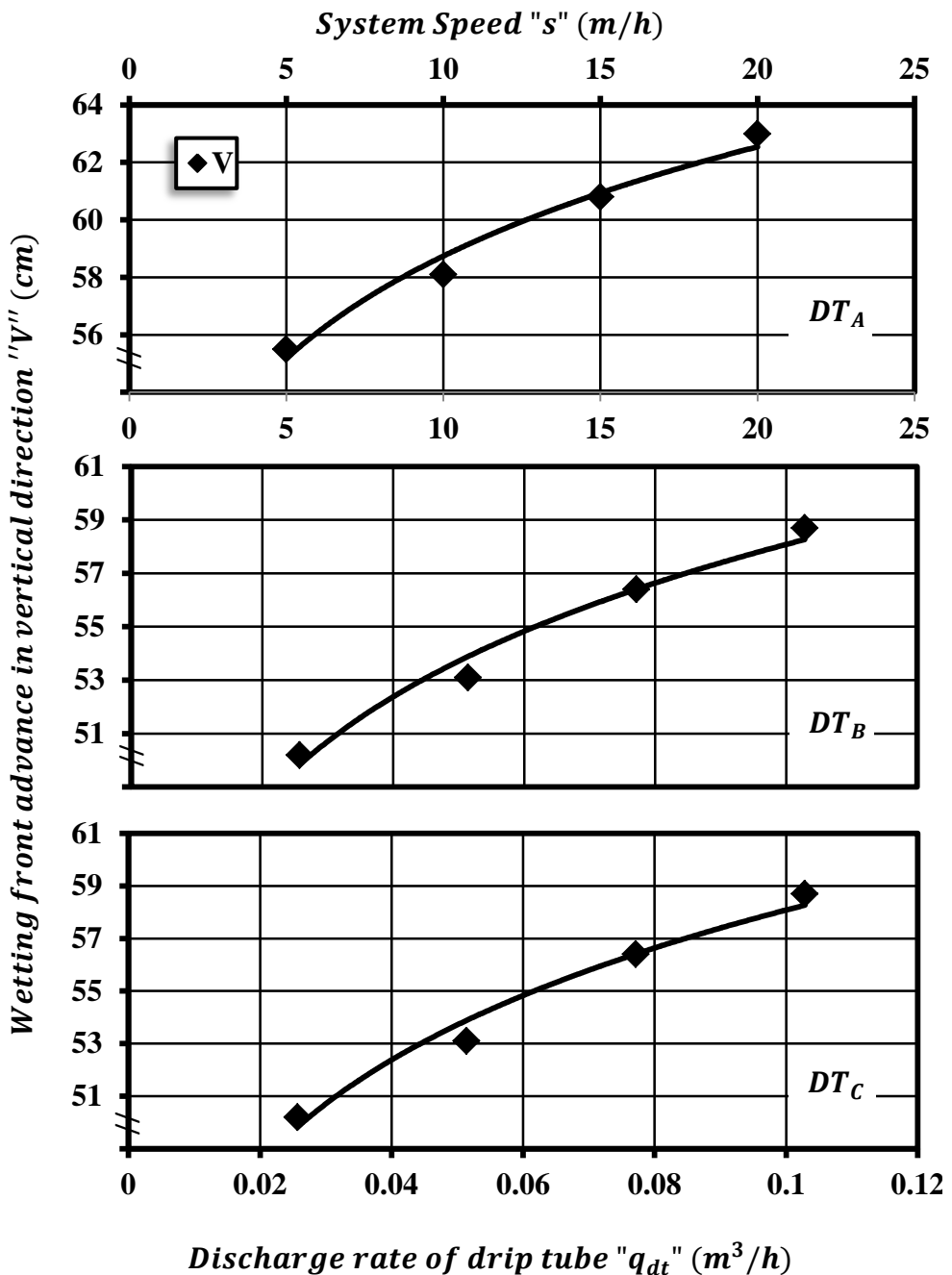

Fig. (8): Relation between discharge rate of drip tube "q_{dt}" (m³/h) and vertical wetting front advance "V" (cm) at using different drip tubes (DT_A, DT_B, and DT_C) and 50 cm distance between drip tubes.

The values of vertical wetting front advances " V " (cm) were increased by increase both discharge rate of drip tube and system speed. Wherever, the values increased from 55.5, 50.2, and 48.2 cm to 63.0, 58.7, and 55.0 cm, at using DT_A , DT_B , and DT_C respectively. Discharge rate of drip tube was ranging from 0.027 to 0.109 m^3/h when using DT_A and DT_C types and from 0.026 to 0.103 m^3/h when using DT_C . Whereas, system speed was ranging from 5 to 20 m/h respectively. The deeper wetting front advance was at using DT_A at all system speed. The wetting front advance in horizontal (H) and diagonal directions (D) do not measured because of an overlapping in the wet.

CONCLUSION

Technology of mobile drip irrigation system "MDIS" combines the efficiency of surface drip irrigation with the flexibility of center pivot and linear move irrigation systems. Also, MDIS technology provides increased system application efficiency through precision drip irrigation with the slow methodical release of water and nutrients directly to the soil area for optimal plant growth. The main objectives of this study were to investigate the design of mobile drip irrigation system "MDIS" by using classic dripping irrigation materials and evaluate of its performance.

The results of presented drip tubes indicate that the classification of flow regime according to the value of the emitter discharge exponent was fully pressure compensating. the C_v (%) is less than 5%, during all ranges of pressure heads and drip tubes, which classifies them as "good" and within permissible limit. On the basis of EU (%), all drip tubes performed more than 91%, also in "good class" and shows, that good indicator to reduce the head loss and saving of energy during system operation. The application efficiency of MDIS was higher than 82%.

Also, the results obtained the following equation to describe wetting front advance in horizontal " H ", vertical " V ", and diagonal " D " directions in loamy sand soil:

$$\alpha = a q_{dt}^c$$

or

$$\alpha = b S^c$$

Where α : is in any direction ($H, V, \text{ and } D$), q_{dt} : is discharge rate of drip tube, (m^3/h), S : is mobile drip irrigation system speed (m/h), and $a, b, \text{ and } c$: are constants depend on type of soil.

REFERENCES

- Al-Qinna, M. I. A. M. Abu-Awwad, 2001.** Wetting Patterns under Trickle Source in Arid Soils with Surface Crust. J. agric. Eng. Res., 80(3): 301-305.
- ASABE Standards, 1999.** EP 458. Field evaluation of microirrigation systems. St. Joseph, Mich.: ASABE. (**C.F. Dutta, 2008**)
- ASAE Standards, 1994.** EP405.1. Design and installation of microirrigation systems. St. Joseph, Mich.,: ASAE.
- Dutta, D. P., 2008.** Characterization of drip emitters and computing distribution uniformity in a drip irrigation system at low pressure under uniform land slopes. Master Thesis. Texas A & M University. Major Subject: Biological & Agricultural Engineering.
- FAO, 2002.** Localized irrigation systems; Planning, Design, Operation and maintenance. Developed by Andreas, P., Food and Agriculture Organization of the United Nations, :4(9).
- Goldberg, D., B. Gormat and Y. Bar, (1971).** The distribution of roots, water and minerals as a result of trickle irrigation. Journal of the American Society for Horticultural Science, 96: 645-648.
- Hezarjaribi, A., 2008.** Improvement of application map and a dynamic steering of modified centre pivot irrigation system. Ph.D. Thesis Federal Agricultural Research Centre (FAL) Institute of production Engineering and building research BRAUNSCHWEIG - GERMANY.
- Howell, T. A., D. S. Stevenson, F. K. Aljibury, H. M. Gitlin, I. P. Wu, A.W. Warrick and P. A. C. Raats, 1980.** Design and operation of trickle (Drip) systems. Chap. 16, :663-717. In: Design and operation of farm irrigation systems. M. E. Jensen (ed.), ASAE,

2950 Niles Road, St. Joseph, Michigan, 49085. (**C. F. Phene *et al.*, 1985**)

Keller, J. and D. Karmeli, 1974. Trickle irrigation design parameters. Trans. of the ASAE, 17(4):678-784.

Keller, J. and D. Karmeli, 1975. Trickle Irrigation Design. Rainbird Sprinkler Manufacturing Corporation: Glendora, California, USA; Riverside Printers.

Lamm, F., 2003. Drip irrigation laterals on center pivot irrigation. <https://www.ksre.k-state.edu/irrigate/photos/mdi.html>

Lamm, F. R., E. A. James, and S. N., Franci, 2007. Microirrigation for Crop Production, Design, Operation, and Management. 1st ed., Copyright 2007 Elsevier B.V.: 1.

Marriam, J. L. and L. Keller, 1978. Farm irrigation system evaluation: A guide for management. Utah State University, Logan, Utah. Dept. of Agricultural & Irrigation Engineering.

Netafim, 2016. Precision Mobile Drip Irrigation (PMDI) Heavywall Driplines. <http://www.netafimusa.com/agriculture/products/hwdripperline/p%D9%A7/r%D9%A7e>

Olson, B. L. S. and D. H., Rogers, 2008. Comparing drag hoses verses sprinklers on corn irrigated by a center pivot. Trans. of the ASAE, 24(1):41-45.

Phene, C. J., T. A. Howell and M. D. Sikorski, 1985. A traveling trickle irrigation system. Academic Press, Inc. (London) Ltd. Advances in Irrigation, (3) :1-49. (On line) <https://books.google.com.eg/>

Solomon, K., 1977. Manufacturing variation of emitters in trickle irrigation systems. ASAE Paper No.77-2009, American Society of Agricultural Engineers, St. Joseph, MI, 49085.

T-L Irrigation, 2016. Precision Mobile Drip Irrigation (PMDI). tlirr.com/products/precision_mobile_drip_irrigation/

Wu, I. P. and H. M., Gitlin, 1975. Energy gradient line for drip irrigation laterals. J. Irrig. Drain. Div. ASCE 101 (IR4), 323–326.

الملخص العربي

تصميم وتقييم نظام ري بالتنقيط متحرك

(^٢) علاء الدين على محمد المسيري

(^١) محمد فايد عبد الفتاح خيرى

(^٤) مصطفى حسن مصطفى فايد

(^٣) فتحى إبراهيم محمد زبادي

تجمع فكرة نظام الري بالتنقيط المتحرك بين مزايا نظم الري بالرش المتحركة والمتمثلة في المرونة والحركة وقلة العمالة المطلوبة ومزايا الري بالتنقيط المتمثلة في دقة توزيع المياه وتجانسها والإقتصاد في مياه الري بالإضافة إلى تقليل فواقد التبخر وكذا الكفاءة المرتفعة في إضافة المياه التي تصل إلى حوالى ٩٥%.

يهدف البحث إلى:

(١) تصميم نظام ري بالتنقيط متحرك (يتحرك في خط مستقيم).

(٢) تقييم نظام الري بالتنقيط المتحرك، من حيث علاقات الضغط بالتصرف ومعامل الاختلاف التصنيعى لأنابيب التنقيط المختلفة وانتظامية توزيع المياه من أنابيب التنقيط المختلفة وحساب كفاءة إضافة المياه للنظام.

(٣) دراسة بعض عوامل التصميم المختلفة مثل سرعة الجهاز والمسافة بين أنابيب التنقيط وكذا الأنواع المختلفة من أنابيب التنقيط.

تم في البحث هذا استخدام أربع سرعات مختلفة لجهاز الري بالتنقيط المتحرك هي ٥، ١٠، ١٥ و ٢٠م/ساعة. كما تم استخدام ثلاثة أنواع مختلفة من أنابيب التنقيط هي DT_A و DT_B و DT_C . الأولى عبارة عن أنبوب تنقيط (قطره الخارجى ١٦ مم والداخلى ١٤ مم) مركب عليه عدد من المنقطات تصرف المنقط الواحد ٨ لتر/س والثانى مركب عليه منقطات تصرف الواحد منها ٢٥ لتر/ساعة أما أنبوب التنقيط الثالث فتصرف المنقط الواحد عليه ٤٠ لتر/ساعة. وكذا استخدام مسافتين بين أنابيب التنقيط هما ٥٠ و ١٠٠ سم.

تم قياس تقدم جبهة البذل في الإتجاهات الأفقى والرأسى والإتجاه القطرى (بزواوية ٤٥ مع الأفقى) تحت الأنواع الثلاثة من أنابيب التنقيط باستخدام السرعات الأربع والمسافتين بين أنابيب التنقيط.

(^١) أستاذ القوى والآلات الزراعية – كلية الهندسة الزراعية – جامعة الأزهر بالقاهرة.

(^٢) أستاذ نظم المياه والرى المزرعى – كلية الهندسة الزراعية – جامعة الأزهر بالقاهرة.

(^٣) أستاذ م. نظم المياه والرى المزرعى – كلية الهندسة الزراعية – جامعة الأزهر بالقاهرة.

(^٤) مدرس مساعد – قسم هندسة نظم المياه والرى المزرعى – كلية الهندسة الزراعية – جامعة الأزهر بالقاهرة.

(البحث مأخوذ من رسالة الدكتوراه الخاصة بالباحث "٤")

أظهرت النتائج باستخدام التحليل الرياضي أنه يمكن حساب تقدم جبهة الببلل في الإتجاهات الثلاثة الأفقى والرأسى والقطرى للتربة الرملية اللومية باستخدام أحد المعادلتين التاليتين:

$$\alpha = a \cdot q_{dt}^c$$

$$\text{or} \quad \alpha = b \cdot S^c$$

حيث:

- α : اتجاه الببلل (أفقى أو رأسى أو قطرى) (سم)
 q_{dt} : تصرف أنبوب التنقيط الواحد على برج الرى بالتنقيط المتحرك (م³/ساعة)
 S : السرعة التى يتحرك بها برج الرى (م/ساعة)
 a, b and c : ثوابت تعتمد على اتجاه الببلل لكل من q_{dt} ، S وقيمها كما هو موضح بالجدول التالى:

قيم الثوابت a, b , and c المستخدمة في المعادلتين السابقتين مع تصرف أنبوب التنقيط (q_{dt}) أو السرعة (S) التى يتحرك نظام الرى بالتنقيط المتحرك لحساب انتشار الببلل (α) في الإتجاهات الأفقى (H) والرأسى (V) والقطرى (D):

Wetting direction "α"	q_{dt}		S	
	a	b	a	b
H	80.033	0.144	41.266	0.144
V	76.863	0.143	40.115	0.143
D	71.541	0.094	47.196	0.094
Mean	76.146	0.127	42.859	0.127